

Standard Preparation 1400 mm Worktop Cupboard with Upstand, Shelf & Sliding Doors

ITEM # _____

MODEL # _____

NAME # _____

SIS # _____

AIA # _____

132778 (MTN1410PN)

WorkTop Cupboard with 1 shelf, 2 sliding doors and upstand, 1400mm

Short Form Specification

Item No. _____

Made entirely from stainless steel. Inner welded frame in stainless steel. Unique connection of panels to inner frame. The 50mm high worktop in 304 AISI stainless steel, 1mm in thickness, incorporates a layer of sound deadening material and has upturned edges. Upstand (h=100mm) with 8mm rounded edge. Sound-deadened sliding doors. Base panel in 304 AISI stainless steel and height-adjustable intermediate shelf. Mounted on feet, adjustable in height.

Main Features

- Worktop cupboard can be mounted on 125 mm diameter castors (2 with brakes) using the optional accessory kit.
- Handles in stainless steel for better hygiene and reliability.
- Sturdiness, stability and reliability of table accurately tested.

Construction

- Inner welded frame in stainless steel to guarantee superior strength and stability.
- Easy access to the cupboard interior on all lengths guaranteed by the use of only 2 doors.
- 50 mm worktop in 304 AISI stainless steel with upturned edges, incorporates an 18 mm layer of sound deadening material.
- Reinforced side and base panel in 304 AISI stainless steel.
- Equipped with intermediate shelf which can be positioned at three different heights.
- Sturdy sound-deadened sliding doors on tracks located flush to the front of the frame.
- Intermediate shelf in stainless steel with riveted corners and trasversal reinforcement in stainless steel.
- 100 mm upstand with 10 mm radiused corner and 13 mm deep, designed to be used against a wall.
- Base panel has 40mm high profile, is 8/10 in thickness with upturned edges and bar reinforcement. It is welded to legs for further structure reinforcement.
- Upstand back completely covered with Stainless Steel welded profile.
- 304 AISI stainless steel feet, 150 mm high and 54 mm in diameter, adjustable by -35/+25 mm.

Optional Accessories

- Wheel kit for cupboards, 4 wheels (2 with brakes), D=1000 mm PNC 855299

APPROVAL: _____

Key Information:

Cabinet width:		
132778 (MTN1410PN)	1345 mm	
Cabinet depth:	645 mm	
Cabinet height:	610 mm	
External dimensions, Width:	1400 mm	
External dimensions, Depth:	700 mm	
External dimensions, Height:	1000 mm	
Upstand Dimensions, Height:	100 mm	
Upstand Dimensions, Depth:	13 mm	
Upstand Dimensions, Radius:	R=10	
Number and type of doors:	2 Sliding	
Worktop thickness:	50 mm	
Net weight:	60 kg	

Front

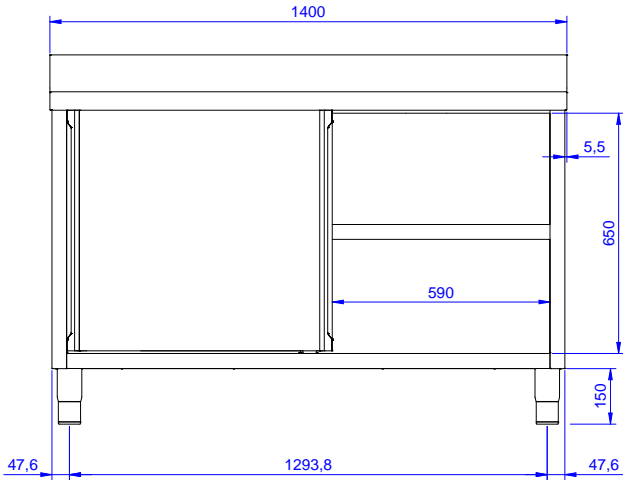

Side

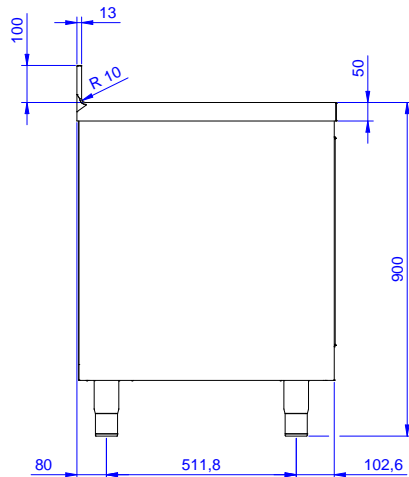

Top

